

Porta-Sifter®

The Porta-Sifter is an inexpensive, versatile, "go-anywhere" vibrating screener perfect for research, batch runs, or continuous production. Its simplistic design and fewer moving parts require minimal maintenance while providing top screening performance.

The vibrating action can be generated wherever electrical or pneumatic connections are available. The electric model is available with a 110-volt single phase or a 230/460-volt three-phase motor. The variable amplitude allows selection of the most efficient vibrating screening action for different meshes and materials.

Batch or continuous screening operations can benefit from the various options. A roll-away stand allows for easy movement between different screening locations without the added expense of multiple screening units. The Porta-Sifter can also sit on a 55-gallon drum to provide an instant screening station.

- Affordable sifting solution
- Many mounting options available
- Transitions well between applications and various departments

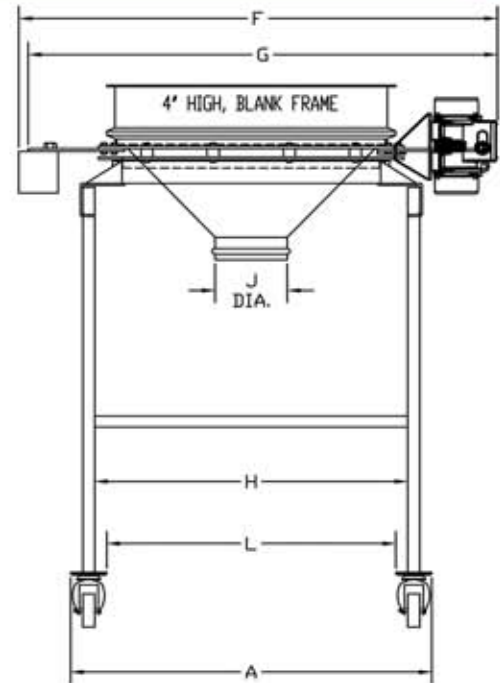
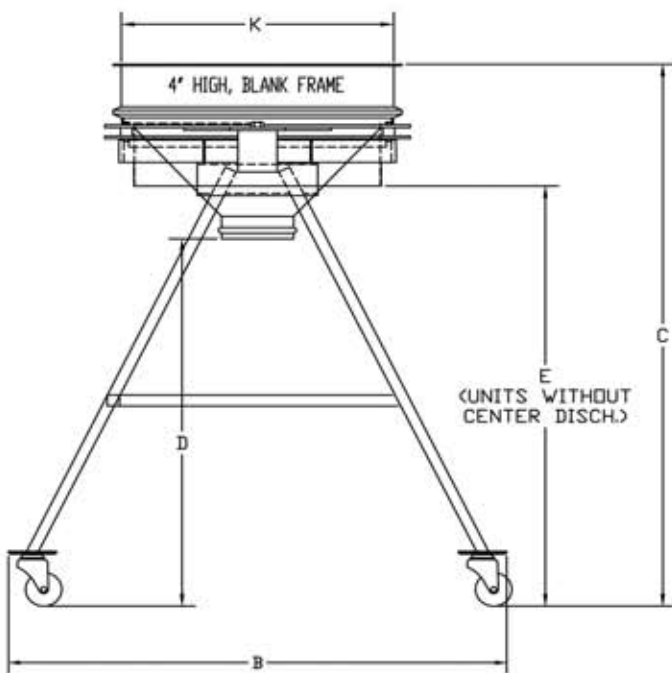

MODEL	A	B	C	D	E	F ELEC	G AIR	H	J DIA.	K DIA.	L
M25	22 1/2"	41 1/2"	47 3/4"	34 5/16"	37 11/16"	33 1/8"	32 5/16"	18 1/2"	4"	16 1/4"	16 1/2"
M55	30"	41 1/2"	48 3/4"	33 1/16"	37 13/16"	39 3/4"	38 15/16"	26"	6"	22 1/2"	24"



Porta-Sifter® Accessories

The Porta-Sifter can be equipped with a wide range of accessories for various applications or material handling needs.



Center Discharge

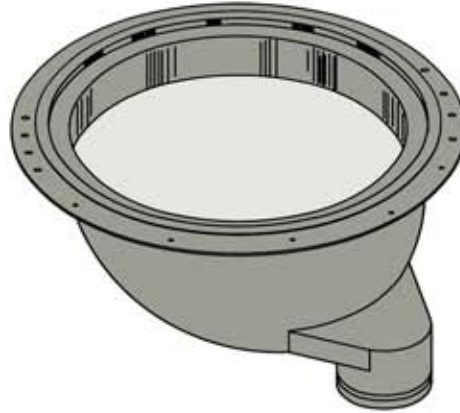

90 Degree Discharge

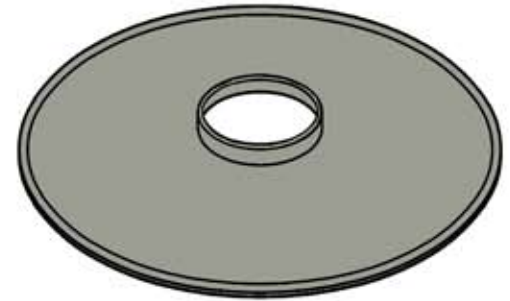

Screen Cover



Roll-Away Stand



Drum Mount

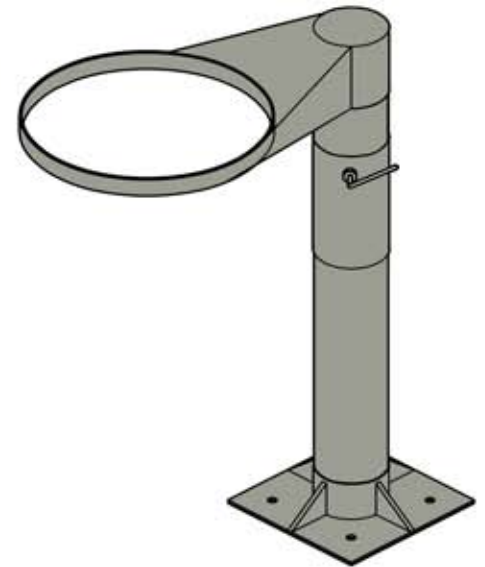

Floor Stand

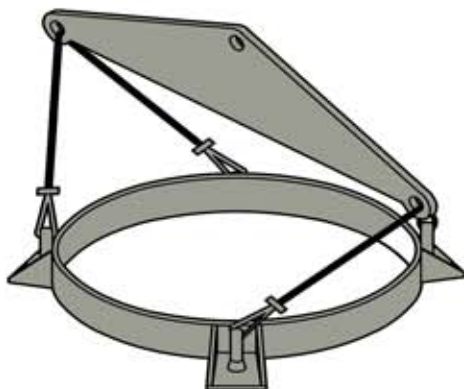

Overhead Trolley



Swing-Away Wall Mount