

Custom Wire Weaver



To insure durability and longevity with our screen panels, Midwestern weaves our own wire cloth to the highest specifications. Offering a large variety of woven wire screen cloth including high carbon, oil tempered, type 304 and 316 stainless steel, and type 430 magnetic stainless steel. Midwestern can accommodate your screening applications with quality products and on-time deliveries.

| Standard Wire Diameters | | |
|-------------------------|-------------|--------------|
| Diameter In Inches | Millimeters | Gauge Number |
| .500 | 12.700 | |
| .4375 | 11.113 | |
| .375 | 9.525 | |
| .3125 | 7.93 | |
| .307 | 7.800 | 0 |
| .283 | 7.188 | 1 |
| .263 | 6.680 | 2 |
| .250 | 6.350 | 3 |
| .225 | 5.715 | 4 |
| .207 | 5.258 | 5 |
| .192 | 4.877 | 6 |
| .177 | 4.496 | 7 |
| .162 | 4.115 | 8 |
| .148 | 3.759 | 9 |
| .135 | 3.429 | 10 |
| .120 | 3.048 | 11 |
| .105 | 2.667 | 12 |
| .092 | 2.337 | 13 |
| .080 | 2.032 | 14 |
| .072 | 1.829 | 15 |
| .063 | 1.600 | 16 |
| .054 | 1.372 | 17 |
| .047 | 1.194 | 18 |
| .041 | 1.041 | 19 |
| .035 | .889 | 20 |
| .032 | .813 | 21 |
| .028 | .711 | 22 |



Interkleen® Screens

An elongated slotted screen with triple shoot construction designed to maximize throughput.

Klear Screens

Straight and crimped wires are woven side by side in an elongated pattern to maintain sizing requirements while giving the screen added elasticity to reduce material from blinding.

Slotted Screens

Slotted screens offer greater throughput by increasing the amount of open area. Available with single shoot or triple shoot construction.

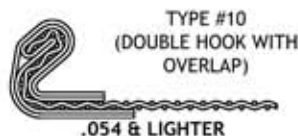
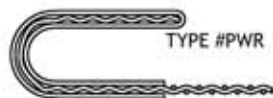
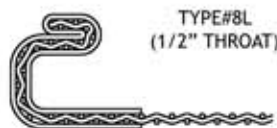
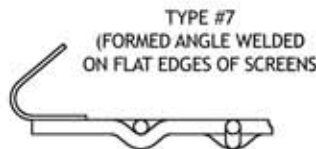
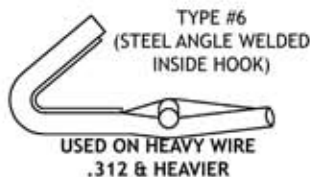
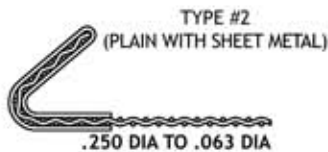
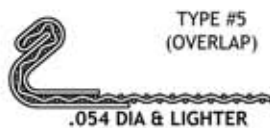
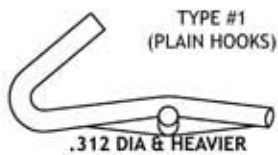

Note: For hook types not shown above, please consult our sales team. Almost any type of hook can be supplied.

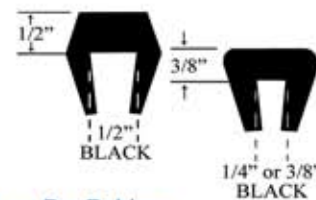

Crown Bar Rubber

Midwestern offers crown-bar rubber, in stock, ready for immediate shipment.



Side Rails

Midwestern can manufacture side rails for nearly every make and model of rectangular screeners.



Carriage Bolts

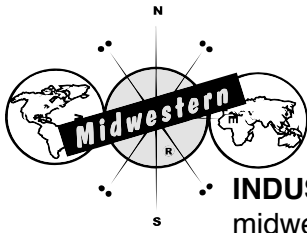

INDUSTRIES, INC.
 midwesternind.com
 Toll Free: (877) 474-9464

P.O. Box 810
 Massillon, OH 44648-0810
 Fax: (330) 837-4210

Southern Facility
 7560 Industrial Highway
 Macon, GA 31216
 Fax: (478) 781-8746

REQUEST TO QUOTE SCREEN PANELS

COMPANY: _____
 ADDRESS: _____
 CITY: _____ STATE: _____ ZIP: _____
 CONTACT NAME: _____
 PHONE NO.: _____ FAX NO.: _____
 E-MAIL: _____

MATERIAL TYPES
 SS - STAINLESS STEEL
 OT - OIL TEMPERED
 HC - HIGH CARBON

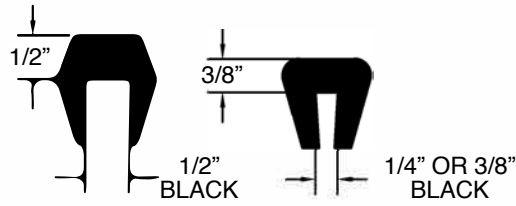
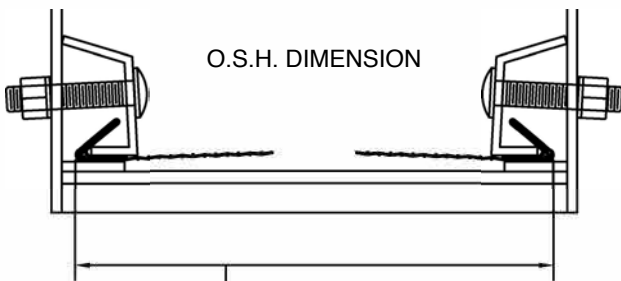
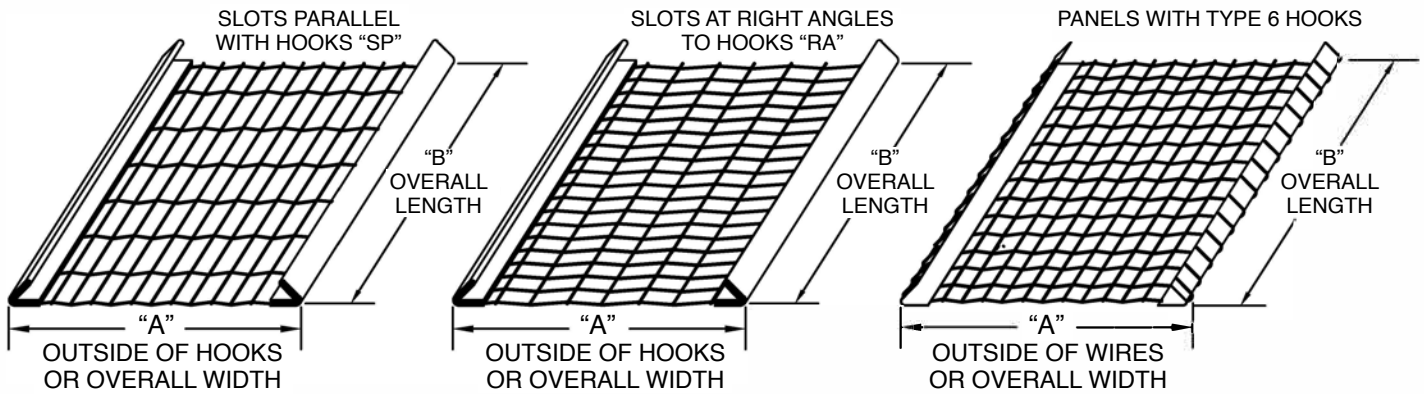

CROWN BAR RUBBER

| NUMBER OF SCREENS | "A" WIDTH (O.S.H.) | "B" LENGTH | WIDTH AND LENGTH OF OPENING, MESH, OR C.O. | DIA. OF WIRE | HOOKS OR EDGE PREP. | SLOTS "RA" / "SP" | MAT'L |
|-------------------|--------------------|------------|--|--------------|---------------------|-------------------|-------|
| | | | | | | | |
| | | | | | | | |
| | | | | | | | |

NOTE: SCREENS WITH BOLT HOLES:
 STATE SIZE, NUMBER OF HOLES AND LOCATION
 (PLEASE FURNISH A SKETCH)